



# AA1600M AIR-ASSIST AIRLESS SPRAY GUN

(0909-1600-XXXXXX)

(WITH FLAT TIP/TWIST TIP OPTION,  
FAN SIZE ADJUSTMENT FEATURE AND  
HVLP/LVMP TECHNOLOGY)

CE  II 2 G X

English: Pages 1 – 12  
Español: Páginas S-1 – S-12  
Français: Pages F-1 – F-12

The following instructions provide the necessary information for the proper operation and preventive maintenance of the Binks AA1600M Air-Assist Airless Spray Gun. Please read and understand all information in this document in order to get the maximum performance from your new AA1600M spray gun.

In the AA1600M spray gun, the paint or other material to be sprayed is pre-atomized and forced through the carbide tip by the typical 400-800 psi fluid pressure (with capabilities up to 1,600 psi/110 bar). As a result of the pre-atomizing, the final shaping air supplied by the air cap produces an exceptionally fine and even spray pattern. The result of this spray pattern is an even finish that lends itself to products that need an exceptionally fine finish with reduced overspray and VOC emissions.

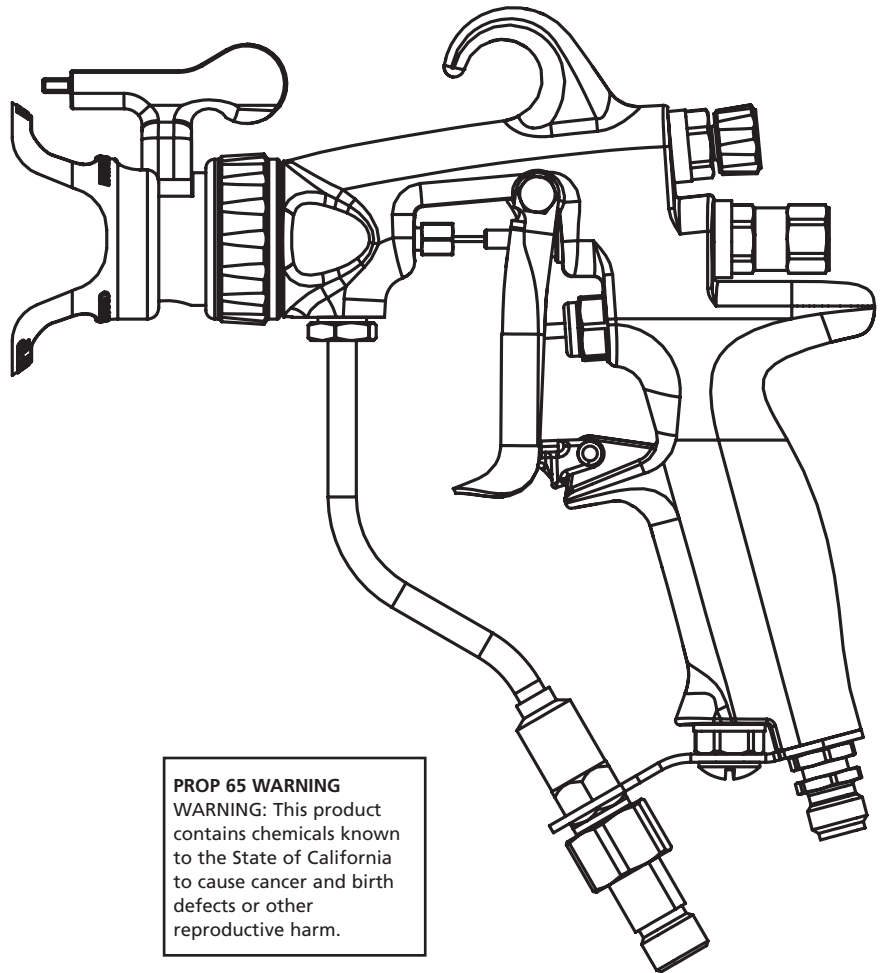

**PROP 65 WARNING**  
WARNING: This product contains chemicals known to the State of California to cause cancer and birth defects or other reproductive harm.

## SPECIFICATIONS:

Maximum Fluid Pressure:	1600 psi/110 bar
Maximum Air Pressure:	100 psi/6.8 bar
Gun Body:	Forged Aluminum
Fluid Path:	Stainless Steel
Fluid Seat:	UHMW (Tungsten Carbide optional)
Fluid Inlet Size:	1/4" NPS(m) Thread
Air Inlet Size:	1/4" NPS(m) Thread
Gun Weight:	17.28 oz./490 g (without Tip, Aircap, Guard)

## IMPORTANT! DO NOT DESTROY

It is the customer's responsibility to have all operators and service personnel read and understand this manual.

Contact your local Binks representative for additional copies of this manual.

**READ ALL INSTRUCTIONS BEFORE OPERATING THIS BINKS PRODUCT**

Replaces  
Part Sheet  
77-2921R-2

Part  
Sheet  
77-2921R-3

# ⚠ WARNING



HIGH PRESSURE CAN CAUSE SERIOUS INJURY IF EQUIPMENT IS INSTALLED OR USED INCORRECTLY.

**READ, UNDERSTAND, AND OBSERVE ALL WARNINGS AND INSTRUCTIONS IN THIS MANUAL.**

**OPERATE EQUIPMENT ONLY AFTER ALL INSTRUCTIONS ARE CLEARLY UNDERSTOOD.**

In this part sheet, the words **WARNING**, **CAUTION** and **NOTE** are used to emphasize important safety information as follows:

**⚠ WARNING**  
 Hazards or unsafe practices which could result in severe personal injury, death or substantial property damage.

**⚠ CAUTION**  
 Hazards or unsafe practices which could result in minor personal injury, product or property damage.

**NOTE**  
 Important installation, operation or maintenance information.

### INJECTION HAZARD

Spray from the gun, hose leaks, or ruptured components can inject fluid into your body and cause extremely serious injury, including poisoning or the need for amputation. Splashing fluid in eyes or on skin can also cause a serious injury.

- Fluid injected into the skin might look like just a cut, but is a serious injury and should be treated as such. **GET IMMEDIATE MEDICAL ATTENTION. INFORM THE PHYSICIAN WHAT TYPE OF MATERIAL WAS INJECTED.**
- Do not point the spray gun at anyone or any part of the body.
- Do not put fingers or hand over the spray tip.
- Do not stop or detect fluid leaks with a rag, hand, body or glove.
- Do not use a rag to blow back fluid. **THIS IS NOT AN AIR SPRAY GUN.**
- Engage the gun safety when not spraying.
- **ALWAYS RELIEVE THE PRESSURE WHENEVER WORKING ON THE SPRAY GUN.**
- Tighten all fluid connections before operating equipment.
- Check all hoses, tubes, and couplings daily. Replace all worn, damaged, or loose parts immediately.

**⚠ WARNING**  
 For pressures over 1000 psi the tip guard must be in place for added protection against skin injection.

Hazardous fluids or toxic fumes can cause serious injury or death if splashed on skin or in the eyes, swallowed or inhaled.

### TOXIC FLUID HAZARD

- Know the specific hazards of the fluid you are using. This information is on the MSDS for the material being used. Read all fluid manufacturer's warnings.
- Store hazardous fluids in approved containers only. Dispose of all hazardous fluids in accordance with all state, local and national guidelines.
- Wear the appropriate protective clothing, gloves, eyewear and respirator.

Equipment misuse can cause the equipment to fail, malfunction, or start unexpectedly and result in serious injury.

### EQUIPMENT MISUSE HAZARD

- This equipment is for professional use only.
- Read and understand all instructional manuals, tags, and labels before operating equipment.
- Use the equipment only for its intended purpose. If you are unsure about its purpose call your local Binks distributor.
- Do not alter or modify this equipment. Use only genuine Binks parts.
- Do not exceed the maximum working pressure of the lowest rated system component. **THE MAXIMUM RATING OF THE AA1600M IS 1600 PSI (110 BAR) FLUID PRESSURE. DO NOT EXCEED THE FLUID PRESSURE RATING.**
- Route all hoses away from all sharp edges, moving parts, hot surfaces and high traffic areas.
- Do not use hoses to pull the equipment.
- Use only Binks approved hoses. Do not remove spring guards from hoses, these are on the hoses to prevent rupture from kinking at the connectors.
- Use only solvents compatible with hoses and wetted parts of the equipment used.
- Comply with all applicable local state and national fire, electrical, and other safety regulations.

Improper grounding, poor air ventilation, open flames, or sparks can cause a hazardous condition and result in fire or explosion and cause serious injury.

### FIRE AND EXPLOSION HAZARD

- Ground the equipment and object being sprayed.
- Provide fresh air ventilation to avoid the build up of flammable fumes from the material being sprayed or from solvent.
- Extinguish all open flames or pilot lights in spray area.
- Electrically disconnect all equipment in the spray area.
- Keep the spray area free from all debris, including solvent rags.
- If there is any static sparking while using the equipment, **STOP SPRAYING IMMEDIATELY.** Identify and correct problem.

### NOISE LEVELS

- The A-weighted sound level of spray guns may exceed 85 dB(A) depending on the setup being used. It is recommended that ear protection is worn at all times when spraying.

The Spray Gun models listed in the following declaration of conformity may be used in some potentially explosive atmospheres **ONLY** when the special conditions for safe installation and operation have been followed as expressed in this user manual (Part Sheet). These models are approved to ATEX regulations 94/9/EC, protection level: **II 2 G X**; Suitable for use in Zones 1 and 2.

**EC Declaration of Conformity**

Manuf. By: ITW Industrial Finishing  
 195 Internationale Blvd.  
 Glendale Heights, IL 60139

Type/Series: Handheld Spray Guns  
 Model: AA1600M, AA4400M

The equipment to which this document relates is in conformance with the following standards or other normative references:  
**EN ISO 12100-1&2:2003** and **BS EN 1953:1999** and thereby conform to the protection requirements of Council Directive 98/37/EC relating to Machinery Safety Directive, and;  
**EN 13463-1:2001**, Council Directive 94/9/EC relating to **Equipment and Protective Systems for use in Potentially Explosive Atmospheres**, protection level **II 2 G X**.

Approved By: Paul Micheli, ITW Industrial Finishing  
 Date: December 3, 2009

CE

## SPRAY GUN SET-UP

### NOTE

Before proceeding, make sure trigger lock is engaged.

1. Connect your high-pressure fluid hose to the gun fluid inlet and tighten securely.
2. Connect your air hose to the gun air connection and tighten securely.
3. Slowly increase air to the pump to obtain a fluid pressure at the gun's lower end of the pressure range. A typical starting fluid pressure is 250 psi. Actual starting pressure points may be higher or lower than 250 psi and depend on the setup including the type of pump used, the type of material sprayed, and the spray gun itself.
4. Using the control knob on the air regulator, set the air pressure at zero.
5. To test the spraying pattern, spray a piece of wood or cardboard with a fast pass about one foot away from the surface. The results of the test will allow you to determine the uniformity of the particle size and spraying pattern.
6. If the spraying pattern develops tails or is not uniform, gradually increase the air pressure as necessary to develop a uniform spraying pattern. 14 psi is the maximum inlet air pressure for HVLP (15 psi max. for HVLP twist tip cap), or use 20-40 psi inlet air pressure for LVMP. **The HVLP flat tip and twist tip air caps consume 8.3 SCFM air at their respective maximum inlet air pressures. The LVMP flat tip and twist tip air caps consume 13 SCFM at 30 psi inlet air pressure.** The air is used to assist the atomization of the coating.
7. If the quality of spray is acceptable, begin spraying. If the spraying rate is too slow to keep up with the production line speed, or if the quantity of material sprayed is inadequate for acceptable coverage, gradually increase the fluid pressure in 50 psi increments using the fluid regulator control knob. However, note that as the fluid pressure increases, more air is needed to eliminate the tails.

Consistency in spraying can be increased across spray gun operators and similar spraying jobs by developing pressure standardization charts. Repeat step 6 until the required material coverage and spraying speed are achieved. If the maximum fluid pressure is reached before the required material coverage and spraying speed are achieved, you may need to switch to a larger fluid tip.

### TYPICAL HOOK-UP

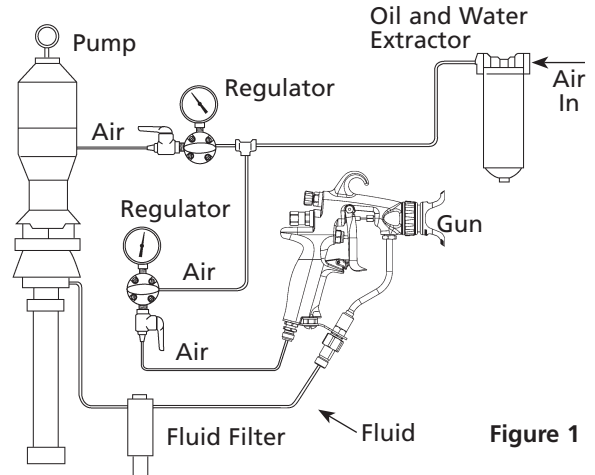

Figure 1

Fan pattern adjustment: turn knob counterclockwise to decrease pattern; clockwise to increase pattern (Fig. 2).

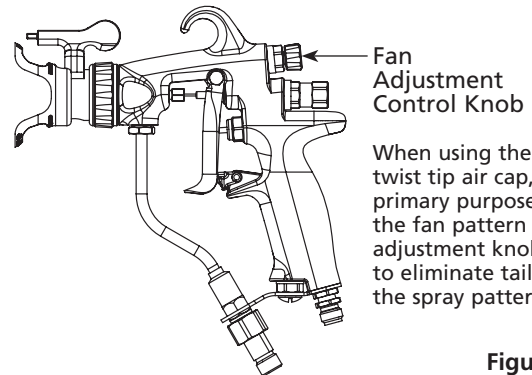

Figure 2

### NOTE

For HVLP spray, fan adjustment feature requires 14 psi max. of air inlet pressure (15 psi max. for HVLP twist tip.) For LVMP spray, fan adjustment requires approximately 20-40 psi of air inlet pressure. Higher fluid pressure requires higher air inlet pressures to accommodate pattern adjustment.

### NOTE

Do not hang gun by trigger. This will cause needle damage or malfunction.

## FLUID TIP SELECTION

Factors to consider in selecting a fluid tip for an air-assist airless spray gun include (1) the size of the parts being sprayed; (2) the production line speed; (3) the material flow rate and film thickness; (4) the viscosity of the material applied; (5) the type of material applied; and (6)

the quality of atomization of the coating required. The selection of a fluid tip necessary to perform a specific spraying job is best determined through a combination of experimentation and expert advice from your material and equipment suppliers.

## FLUID HOSES

Air-assist airless spray guns operate at fluid pressures higher than operating pressures of air spray guns. As a result, when operating an air-assist airless spray gun, it is

critical to select the appropriate fluid hose that is rated for the pressure range at which the airless gun is operated.

## TROUBLESHOOTING DEFECTIVE SPRAY PATTERNS

### ⚠ CAUTION

Always engage trigger lock and relieve fluid pressure before servicing gun.

The following procedure summarizes the steps that an operator must immediately take when the first signs of a defective spray pattern emerge.

1. Check the external portion of the fluid tip for material buildup. If buildup has occurred, secure the gun trigger safety switch and clean the gun fluid tip with a non-metal soft brush.
2. If the spray pattern exhibits signs of tails at the top or bottom ends of the pattern, increase the air pressure gradually until the tails disappear.
3. If increasing air pressure does not dissipate the tails, the fluid tip may be worn and may need to be

replaced. Another sign of the need to replace a worn tip is a gradual decline in spraying pattern width.

4. If cleaning or replacing the fluid tip does not dissipate the tails; the spraying defect is most likely due to the material temperature and/or viscosity.
5. If pattern pulsation or blinking occurs, check the pressure regulators, all downstream regulators, and the pump. These may require further adjustment or even repairs.

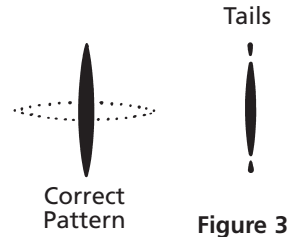

## GENERAL TROUBLESHOOTING

(Refer to page 12 when referencing part numbers in brackets.)



PROBLEM	CAUSE	ACTION
Fluid leaking from through the seal	Worn seal or needle shaft. Loose needle seal.	Replace needle assembly (18). Tighten packing nut gently until leak stops.
Fluid leaking from the front of the gun	Needle ball worn or damaged. Worn seat assembly.	Replace needle assembly (18). Replace fluid seat (3/3A).
Fluid in air passages	Spray tip seal leaking. Leaking around fluid seat.	Tighten air cap/nozzle guard assembly (7) Replace carbide tip assembly (5/5A). Tighten or replace fluid seat (3/3A).
Slow fluid shut off	Fluid buildup on needle assembly.	Clean or replace needle assembly (18).
No fluid output when triggered	Tip orifice plugged.  Needle is damaged or broken.  Fluid filter or fluid hose plugged.	For flat tip: Turn off fluid supply. Relieve pressure into a closed earth-grounded container. Engage trigger safety. Remove air cap/nozzle guard assembly (6) and the carbide tip (5). Clean or replace carbide tip assembly (5).  For twist tip: Rotate twist tip (5A) in aircap (6A) and spray into a closed-grounded container to try clear tip of any debris. If that fails to unplug the tip then remove, clean and replace twist tip.  Turn off fluid supply. Relieve pressure into a closed-grounded container. Remove trigger (10). Replace needle assembly (18)  Turn off fluid supply. Relieve pressure into a closed-grounded container. Turn off air supply to pump and relieve fluid pressure with bypass valve. Engage trigger safety. Very slowly loosen the hose connection at the gun to relieve any pressure in hose. Remove hose and clear obstruction. NOTE: When replacing filter, use two wrenches—one to hold tube (11) in place and prevent twisting, and the other to remove nut (14). Only tighten nut (14) from 9 to 11 ft.-lbs.

### IMPORTANT REGULATORY NOTE

The AA1600M Air-Assist H.V.L.P. hand spray gun combines the proven efficiency of the Binks compliant spray guns with air-assist atomization to yield a reliable, carefully engineered compliant spray gun. With 25' of 5/16" I.D. air hose and regulator set at only 20 p.s.i. the compliant air cap registers 10 p.s.i. of atomization air to shape and soften the spray pattern. The AA1600M air-assist H.V.L.P. gun operates at high transfer efficiencies and fully complies with all government regulations for H.V.L.P. spray guns.

	Max. Fluid Input:	1600 psi / 110 BAR
Max. static air pressure at regulator with 25' of hose to inlet:	20 psi / 1.4 BAR	
Max. Dynamic Gun Inlet Air Pressure:	14 psi / 1 BAR	
Gun Body:	Forged Aluminum Alloy	
Fluid Path:	Stainless Steel and Tungsten Carbide / UHMW	

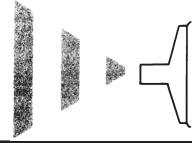
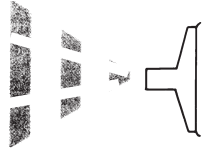
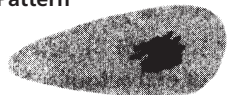
## SPRAY PATTERN TROUBLESHOOTING

PROBLEM	CAUSE	ACTION
<b>Fluttering Spray Pattern</b> 	Insufficient fluid supply.  Air in paint supply line.  Attempting to "feather" (Partially trigger gun).	Adjust fluid regulator or fill fluid supply tanks.  Check and tighten pump siphon hose connections, bleed air from paint line.  Cannot feather with an AA1600M gun.
<b>Striping Spray – Fingers</b> 	Carbide tip partially plugged.	Clean or replace carbide tip assembly.
<b>Irregular Pattern</b> 	Fluid builds up on carbide tip, or tip partially plugged.  On defective side of pattern, air horn holes are plugged.	Clean carbide tip.  Clean air horn holes with solvent and a soft brush.
<b>Pattern pushed to one side, same side of air cap gets dirty</b> 	On defective side of pattern, air horn holes are plugged.	Clean air horn holes with solvent and a soft brush or toothpick.

## AIR-ASSIST AIRLESS SPRAY GUN MAINTENANCE AND CLEANING

Maintenance of air-assist airless spray guns includes (1) fluid tip wear and replacement; (2) lubrication; and (3) cleaning of the gun.

### FLUID TIP

Operating an air-assist airless spray gun with a worn fluid tip will result in increased usage of spraying material and therefore, HAP emissions. For example, an increase in the diameter of a tip from 0.015 inch to 0.021 inch due to wear can result in up to a 100 percent increase in material consumption and cost. To prevent waste in spraying material and non-value-adding costs, a maintenance schedule that includes fluid tip inspection and replacement must be established.

### LUBRICATION

Proper lubrication is essential for optimum spray gun performance. Lubrication allows the equipment to operate easily and correctly. The spray gun should be lubricated after each cleaning. The points that need lubrication during the maintenance of air-assist airless spray guns include the fluid needle packing and trigger pivot point. Gun lube is used to lubricate the fluid needle packing and trigger pivot point.

### ⚠ CAUTION

Never immerse the entire gun in solvent or thinners. Some gun parts will lose their lubricative film and wear more quickly. Additionally, solvents may carry impurities throughout the gun body and allow them to clog small air and fluid passages.

### CLEANING

The following steps summarize the procedure for cleaning air-assist airless spray guns:

1. Turn off the atomizing air supply to the gun.
2. Turn off air supply to the pump and relieve fluid pressure. This may be accomplished by opening the bypass/priming valve, if so equipped.
3. Place the siphon (suction) tube into a solvent container. If pump is directly immersed in material, remove the pump and immerse it in a solvent container.

### NOTE

Use only compatible solvents that are identified as approved for cleaning and wash-off use.

4. Place the gun trigger safety switch in the locked position.
5. Remove the fluid tip and place it in a closed solvent container.
6. Adjust the pump air supply regulator to its lowest level (counter-clockwise).
7. Place the gun trigger safety switch in the unlocked position.
8. Turn on the air supply to the pump and close the bypass/priming valve, if so equipped.
9. Slowly adjust the pump air supply regulator until the pump begins to cycle.
10. Trigger the gun into a closed container until the fluid runs clear.

### ⚠ WARNING

Failure to reduce pump air supply pressure or to use a closed container can result in material "bounce-back". Material "bounce back" can cause injury and damage.

### NOTE

During cleaning, the gun may only be sprayed into a closed container, never flush the gun into the air or spray booth.



## CLEANING *(Continued)*

11. Using a rag dampened with solvent, wipe the exterior surface of the gun. Additionally, some solvents are prohibited from being used for cleaning. The operator must take care to use only approved cleaning solvents for equipment cleaning. These materials are clearly

labeled as approved for cleaning and wash off operations. If the operator has any question on selecting appropriate cleaning solvents, the operator should consult a supervisor or plant environmental staff.

## REPLACING FLUID NOZZLE AND/OR FLUID NEEDLE ASSEMBLY

### REASONS TO REPLACE NOZZLE AND/OR NEEDLE ASSEMBLY:

- A) Fluid leak through fluid nozzle.
- B) Slow shut off of fluid.
- C) No fluid when gun triggered.

### **CAUTION**

Always ensure that all fluid and air pressure to the gun has been discharged before proceeding with any repairs.

### REPLACING THE FLUID NOZZLE

### **CAUTION**

Do not remove fluid tube when replacing the fluid nozzle.

1. Remove air cap along with spray tip. (See fig 4)
2. While fully depressing the trigger remove the fluid nozzle and gasket. (See fig 5)
3. Check baffle plate for wear. If worn replace with new part. (See fig 6)
4. While fully depressing the trigger install the new fluid nozzle and gasket. Torque fluid nozzle from 9 to 11 ft.-lbs. (See fig 5).
5. Replace the air cap along with spray tip. (See fig 4)

### REPLACING THE FLUID NEEDLE ASSEMBLY

1. Remove the trigger by removing the trigger screw and trigger nut. (See fig 7)
2. Completely unscrew needle packing nut. (See fig 8)
3. Unscrew blanking cap and remove the needle spring and pad. (See figs 9 & 10)
4. Ensure the spring pad has not been worn down and clean the spring of any debris. (See fig 11)
5. Remove the needle assembly. (See fig 12)
6. Insert new needle assembly and new spring if necessary. (See figs 12 & 10) Ensure the spring pad is attached to the spring.
7. Screw on blanking cap. (See fig 9)
8. Gently tighten needle packing nut. DO NOT OVER TIGHTEN. (See fig 8)
9. Replace trigger, trigger screw and trigger nut. (See fig 7)
10. Operate gun with fluid and adjust tightness of packing nut as necessary to prevent fluid leak. (See fig 8)



Fig. 4



Fig. 5



Fig. 6



Fig. 7

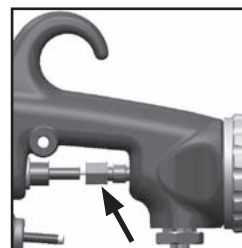

Fig. 8

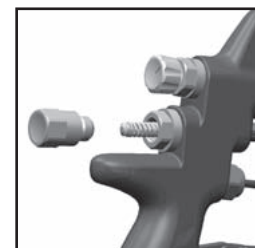

Fig. 9



Fig. 10

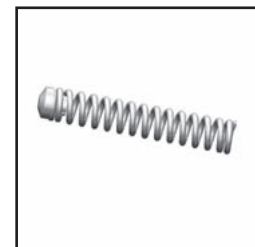

Fig. 11



Fig. 12

## SERVICING AIR VALVE

### REASONS TO SERVICE AIR VALVE:

- A) Air valve not functioning correctly (may need cleaning).
- B) Routine maintenance.
- C) Air leaks (advise replacement, see p8)

### **CAUTION**

Always ensure that all fluid and air pressure to the gun has been discharged before proceeding with any repairs.

1. Remove trigger and fluid tube assembly. (See fig 13 & 14)
2. Unscrew air valve using 14 mm wrench. (See fig 15)
3. Remove air valve by gripping stem. (See fig 16)
4. Remove spring with spring pad. (See fig 17)
5. **DO NOT REMOVE REAR SEAL FROM GUN BODY.**  
(See fig 18)
6. **DO NOT REMOVE PLASTIC CAGE FROM AIR VALVE BODY AS THIS MAY DAMAGE THE CAGE.** (See fig 19)
7. CLEAN
  - a. Remove all paint build up. (See fig 20)
  - b. The 4 poppet holes must be clear. (See fig 21)
  - c. Stem must be free to float in poppet. (See fig 22)
  - d. Stem must slide through cage bore with slight resistance (due to seal).
  - e. Rear seal must look clean and in position in the bore. (See fig 18)
  - f. If any of the above cannot be rectified, replace the air valve. (See Replacing Air Valve p8).
8. Replace spring ensuring the end with the plastic bearing pad goes in first. (See fig 17)
9. Insert air valve assembly into gun and carefully feed over the spring and through the rear seal. (See fig 23)
10. Tighten air valve assembly using fingers first, and then tighten with 14mm wrench. Torque from 18 to 22 ft.-lbs. (See fig 24)
11. Replace the fluid tube and trigger. (See figs 14 & 13)
12. If there is an air leak through the gun, the air valve may need replacing. (See Replacing Air Valve p8)



Fig. 13



Fig. 14



Fig. 15

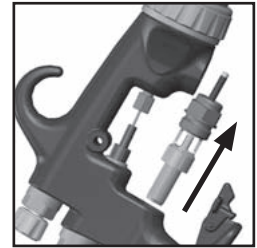

Fig. 16

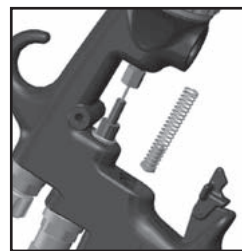

Fig. 17



Fig. 18

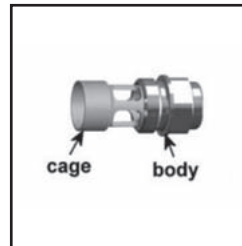

Fig. 19

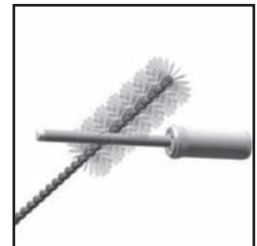

Fig. 20

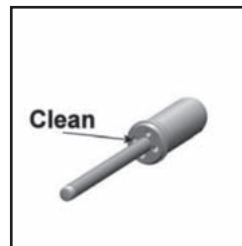

Fig. 21

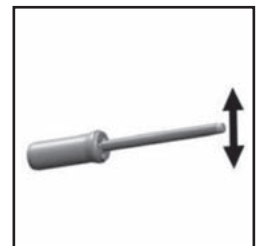

Fig. 22

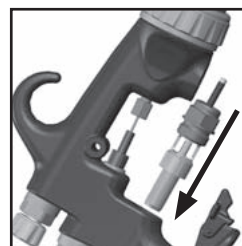

Fig. 23

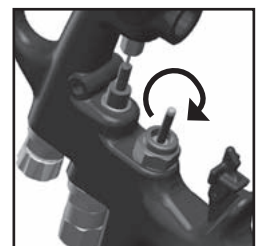

Fig. 24

## REPLACING AIR VALVE

### REASONS TO REPLACE AIR VALVE:

- A) Air leak through the gun.
- B) Air valve not operating correctly.

### **CAUTION**

Always ensure that all fluid and air pressure to the gun has been discharged before proceeding with any repairs.

1. Remove trigger and fluid tube assembly. (See figs 25 & 26)
2. Unscrew air valve using 14 mm wrench. (See fig 27)
3. Remove air valve by gripping the stem. (See fig 28)
4. Remove spring with spring pad. (See fig 29)
5. Hook out rear seal using Service Tool. (See figs 30 & 31)
6. Clean air valve bores in gun body with the brush supplied in the kit.
7. Place new rear seal onto Service tool; grooves must fit in service tool form. (See fig 32)
8. Push rear seal firmly into hole up to shoulder, using Service tool. (See figs 33 & 34)
9. Insert new spring, ensuring the end with the plastic bearing pad goes in first. (See fig 29)
10. Insert air valve assembly into gun and carefully feed over the spring and through the rear seal. (See fig 35)
11. Tighten air valve assembly using fingers first, then tighten with 14 mm wrench. Torque from 18 to 22 ft.-lbs. (See fig 36)
12. Replace fluid tube and trigger. (See figs 26 & 25)



Fig. 25

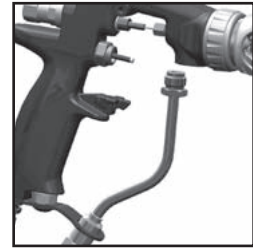

Fig. 26



Fig. 27

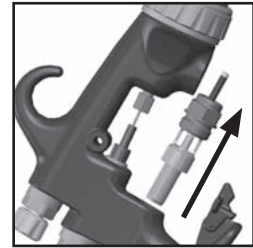

Fig. 28

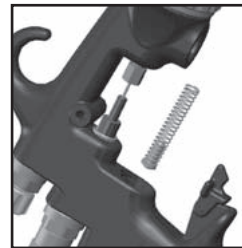

Fig. 29

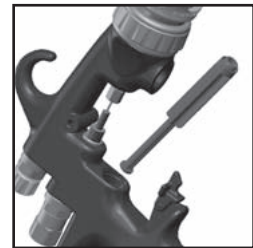

Fig. 30



Fig. 31

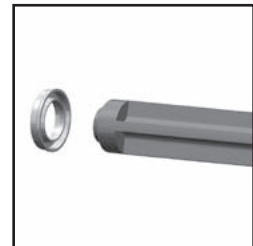

Fig. 32



Fig. 33

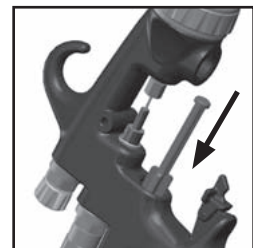

Fig. 34

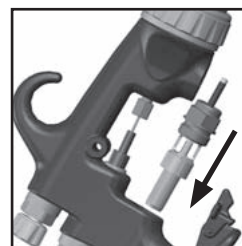

Fig. 35

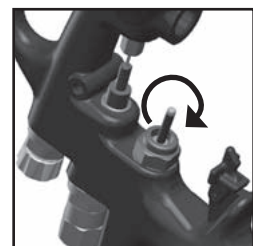

Fig. 36



## TIP GUARD INSTALLATION

### REASON TO INSTALL TIP GUARD:

To replace broken tip guard.

### WARNING

For pressures over 1000 psi the tip guard must be in place for added protection against skin injection.

### CAUTION

Always ensure that all fluid and air pressure to the gun has been discharged before proceeding with any repairs.

### INSTRUCTIONS ARE VALID FOR BOTH FLAT TIP GUARD AND TWIST TIP GUARD:

1. Disconnect all fluid and air hoses from the gun.
2. Insert the gun into a clamping vise with fluid nozzle facing directly upwards. (See fig 37) Gun should be securely clamped at the upper portion of the gun handle.
3. Assemble air cap and air cap ring together – **less spray tip and plastic tip guard**. (See fig 38)
4. Install the air cap and air cap ring assembly onto the gun until it is fully hand tightened. (See fig 39)
5. Slip on the plastic tip guard onto the air cap in proper orientation. (See fig 40)
6. Place round bar screwdriver (approx. 12” long) between open sections of the plastic guard and push down with even pressure on both sides of the plastic guard. (See fig 41)
7. The guard should snap into air cap groove securely. (See fig 42)
8. The aircap can now be removed to install the appropriate tip for use.



Fig. 37

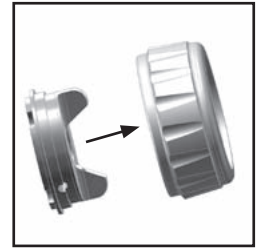

Fig. 38



Fig. 39



Fig. 40

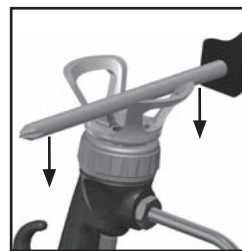

Fig. 41



Fig. 42

## TWIST TIP SELECTION CHARTS

Fan width based on 2200 PSI with latex paint 12" from surface. Actual results may vary, depending on material viscosity.

PART NUMBER	DESCRIPTION	ORIFICE	FAN WIDTH (IN.)	GPM CAPACITY @2200 PSI
9-307-75	TWIST TIP	0.007	6	0.05
9-309-75	TWIST TIP	0.009	6	0.09
9-409-75	TWIST TIP	0.009	8	0.09
9-509-75	TWIST TIP	0.009	10	0.09
9-311-75	TWIST TIP	0.011	6	0.12
9-411-75	TWIST TIP	0.011	8	0.12
9-511-75	TWIST TIP	0.011	10	0.12
9-611-75	TWIST TIP	0.011	12	0.12
9-313-75	TWIST TIP	0.013	6	0.18
9-413-75	TWIST TIP	0.013	8	0.18
9-513-75	TWIST TIP	0.013	10	0.18
9-613-75	TWIST TIP	0.013	12	0.18
9-713-75	TWIST TIP	0.013	14	0.18
9-315-75	TWIST TIP	0.015	6	0.24
9-415-75	TWIST TIP	0.015	8	0.24
9-515-75	TWIST TIP	0.015	10	0.24
9-615-75	TWIST TIP	0.015	12	0.24
9-715-75	TWIST TIP	0.015	14	0.24
9-417-75	TWIST TIP	0.017	8	0.31
9-517-75	TWIST TIP	0.017	10	0.31
9-617-75	TWIST TIP	0.017	12	0.31
9-717-75	TWIST TIP	0.017	14	0.31
9-419-75	TWIST TIP	0.019	8	0.38
9-519-75	TWIST TIP	0.019	10	0.38
9-619-75	TWIST TIP	0.019	12	0.38
9-521-75	TWIST TIP	0.021	10	0.47
9-621-75	TWIST TIP	0.021	12	0.47
9-523-75	TWIST TIP	0.023	10	0.57
9-623-75	TWIST TIP	0.023	12	0.57
9-525-75	TWIST TIP	0.025	10	0.67
9-625-75	TWIST TIP	0.025	12	0.67
9-627-75	TWIST TIP	0.027	12	0.74
9-435-75	TWIST TIP	0.035	8	1.31
9-631-75	TWIST TIP	0.031	12	1.03
9-635-75	TWIST TIP	0.035	12	1.31

## FINE FINISH FLAT TIP SELECTION CHARTS

Fan width based on 1000 PSI with water 12" from surface. Actual results may vary, depending on material viscosity.

PART NUMBER	DESCRIPTION	ORIFICE	FAN WIDTH (IN.)	GPM CAPACITY @500 PSI WATER
9-0909-F	FINE FINISH TIP	0.009	9	0.039
9-0911-F	FINE FINISH TIP	0.009	11	0.039
9-1109-F	FINE FINISH TIP	0.011	9	0.06
9-1111-F	FINE FINISH TIP	0.011	11	0.06
9-1113-F	FINE FINISH TIP	0.011	13	0.06
9-1115-F	FINE FINISH TIP	0.011	15	0.06
9-1309-F	FINE FINISH TIP	0.013	9	0.09
9-1311-F	FINE FINISH TIP	0.013	11	0.09
9-1313-F	FINE FINISH TIP	0.013	13	0.09
9-1315-F	FINE FINISH TIP	0.013	15	0.09
9-1509-F	FINE FINISH TIP	0.015	9	0.12
9-1511-F	FINE FINISH TIP	0.015	11	0.12
9-1513-F	FINE FINISH TIP	0.015	13	0.12
9-1515-F	FINE FINISH TIP	0.015	15	0.12
9-1517-F	FINE FINISH TIP	0.015	17	0.12
9-1709-F	FINE FINISH TIP	0.017	9	0.16
9-1711-F	FINE FINISH TIP	0.017	11	0.16
9-1713-F	FINE FINISH TIP	0.017	13	0.16
9-1715-F	FINE FINISH TIP	0.017	15	0.16
9-1717-F	FINE FINISH TIP	0.017	17	0.16

## STANDARD FLAT TIP SELECTION CHARTS

Fan width based on 1000 PSI with water 12" from surface. Actual results may vary, depending on material viscosity.

PART NUMBER	DESCRIPTION	ORIFICE	FAN WIDTH (IN.)	GPM CAPACITY @500 PSI WATER
114-00702	TIP ASSEMBLY	.007	2	.028
114-00704	TIP ASSEMBLY	.007	4	.028
114-00706	TIP ASSEMBLY	.007	6	.028
114-00708	TIP ASSEMBLY	.007	8	.028
114-00902	TIP ASSEMBLY	.009	2	.039
114-00906	TIP ASSEMBLY	.009	6	.039
114-00908	TIP ASSEMBLY	.009	8	.039
114-00910	TIP ASSEMBLY	.009	10	.039
114-00912	TIP ASSEMBLY	.009	12	.039
114-01104	TIP ASSEMBLY	.011	4	.060
114-01106	TIP ASSEMBLY	.011	6	.060
114-01108	TIP ASSEMBLY	.011	8	.060
114-01110	TIP ASSEMBLY	.011	10	.060
114-01112	TIP ASSEMBLY	.011	12	.060
114-01114	TIP ASSEMBLY	.011	14	.060
114-01304	TIP ASSEMBLY	.013	4	.090
114-01306	TIP ASSEMBLY	.013	6	.090
114-01308	TIP ASSEMBLY	.013	8	.090
114-01310	TIP ASSEMBLY	.013	10	.090
114-01312	TIP ASSEMBLY	.013	12	.090
114-01314	TIP ASSEMBLY	.013	14	.090
114-01316	TIP ASSEMBLY	.013	16	.090
114-01506	TIP ASSEMBLY	.015	6	.120
114-01508	TIP ASSEMBLY	.015	8	.120
114-01510	TIP ASSEMBLY	.015	10	.120
114-01512	TIP ASSEMBLY	.015	12	.120
114-01514	TIP ASSEMBLY	.015	14	.120
114-01516	TIP ASSEMBLY	.015	16	.120
114-01518	TIP ASSEMBLY	.015	18	.120
114-01706	TIP ASSEMBLY	.017	6	.160
114-01708	TIP ASSEMBLY	.017	8	.160
114-01710	TIP ASSEMBLY	.017	10	.160
114-01712	TIP ASSEMBLY	.017	12	.160
114-01714	TIP ASSEMBLY	.017	14	.160
114-01716	TIP ASSEMBLY	.017	16	.160
114-01718	TIP ASSEMBLY	.017	18	.160
114-01906	TIP ASSEMBLY	.019	6	.190
114-01908	TIP ASSEMBLY	.019	8	.190
114-01910	TIP ASSEMBLY	.019	10	.190
114-01912	TIP ASSEMBLY	.019	12	.190
114-01914	TIP ASSEMBLY	.019	14	.190
114-01916	TIP ASSEMBLY	.019	16	.190
114-01918	TIP ASSEMBLY	.019	18	.190
114-02110	TIP ASSEMBLY	.021	10	.240
114-02112	TIP ASSEMBLY	.021	12	.240
114-02114	TIP ASSEMBLY	.021	14	.240
114-02116	TIP ASSEMBLY	.021	16	.240
114-02118	TIP ASSEMBLY	.021	18	.240
114-02410	TIP ASSEMBLY	.024	10	.310
114-02412	TIP ASSEMBLY	.024	12	.310
114-02414	TIP ASSEMBLY	.024	14	.310
114-02416	TIP ASSEMBLY	.024	16	.310
114-02418	TIP ASSEMBLY	.024	18	.310
114-02710	TIP ASSEMBLY	.027	10	.385
114-02712	TIP ASSEMBLY	.027	12	.385
114-02714	TIP ASSEMBLY	.027	14	.385
114-02716	TIP ASSEMBLY	.027	16	.385
114-02718	TIP ASSEMBLY	.027	18	.385

### TWIST TIP NOTE

When switching from flat tip to twist tip, increase pattern size by 2 inches and use air adjustment to turn down to desired size.

## FULL GUN ASSEMBLIES

DESCRIPTION	ASS'Y NUMBER
AA1600M HVLP FLAT TIP GUN ASSEMBLY (NO TIP INCL.)	0909-1600-HF0000
AA1600M HVLP FLAT TIP GUN ASSEMBLY (W/114-01310 TIP)	0909-1600-HF1310
AA1600M HVLP FLAT TIP GUN ASSEMBLY (W/114-01510 TIP)	0909-1600-HF1510
AA1600M HVLP FLAT TIP GUN ASSEMBLY (W/114-01514 TIP)	0909-1600-HF1514

DESCRIPTION	ASS'Y NUMBER
AA1600M HVLP TWIST TIP GUN ASSEMBLY (NO TIP INCL.)	0909-1600-HT0000
AA1600M HVLP TWIST TIP GUN ASSEMBLY (W/9-613-75 TIP)	0909-1600-HT0613
AA1600M HVLP TWIST TIP GUN ASSEMBLY (W/9-615-75 TIP)	0909-1600-HT0615
AA1600M HVLP TWIST TIP GUN ASSEMBLY (W/9-715-75 TIP)	0909-1600-HT0715

## AA1600M AIR-ASSIST AIRLESS SPRAY GUN

### PARTS LIST

When ordering, please specify Part No. (Not all Part Nos. are available for purchasing.)  
Refer to page 12 when referencing Item Nos.

ITEM NO.	PART NO.	DESCRIPTION	QTY.	ITEM NO.	PART NO.	DESCRIPTION	QTY.
1	—	GUN BODY.....	1	9	SN-402-K	AIR VALVE ASSEMBLY.....	1
2	SPA-71-K5	BAFFLE PLATE (KIT OF 5).....	1	10	—▲	TRIGGER.....	1
<b>FLAT TIP COMPONENTS</b>				11	54-5780	FLUID TUBE ASSEMBLY.....	1
3	54-5811-K ‡	FLUID SEAT (1600PSI)..... (UHMW STANDARD, OPTIONAL TUNGSTEN CARBIDE 54-5799-K)	1	12	54-5789-K5 □	FLUID FILTER 100 MESH (KIT OF 5)..... (60 MESH FILTER (KIT OF 5) 54-5788-K5)	1
4	SPA-98-K5	GASKET (KIT OF 5).....	1	13	—>	FLUID INLET SWIVEL (1/4" NPS).....	1
5	114-XXXXX ■	FLAT TIP (FINE FINISH TIPS 9-XXXX-F).....	1	14	—>	FILTER ADAPTER NUT.....	1
6	54-5795-K ▼	FLAT TIP HVLP AIRCAP KIT..... (FLAT TIP LVMP AIRCAP 54-5797-K)	1	15	SN-9-K3	AIR INLET FITTING 1/4" NPS (KIT OF 3).....	1
7	54-5852	RETAINING RING.....	1	16	—●	FILTER BRACKET SCREW.....	1
8	54-5794 ○	FLAT TIP GUARD.....	1	17	—●	FILTER BRACKET.....	1
<b>TWIST TIP COMPONENTS</b>				18	—*	FLUID NEEDLE ASSEMBLY (1600PSI).....	1
3A	54-5833-K ‡	TWIST TIP FLUID SEAT (1600PSI)..... (UHMW STANDARD, OPTIONAL TUNGSTEN CARBIDE 54-5832-K)	1	19	54-5850	BLANKING NEEDLE NUT.....	1
5A	9-XXX-75 ■	TWIST TIP.....	1	20	—*	NEEDLE SPRING PAD.....	1
5B	54-5801-K2	TWIST TIP BRACE (KIT OF 2).....	1	21	—*	NEEDLE SPRING (1600PSI).....	1
6A	54-5796-K ▼	TWIST TIP HVLP AIRCAP KIT..... (TWIST TIP LVMP AIRCAP 54-5798-K)	1	22	54-5815	SPREADER VALVE ASSEMBLY.....	1
7	54-5852	RETAINING RING.....	1	23	—#	BODY BUSHING.....	1
8A	54-5793 ○	TWIST TIP GUARD.....	1	24	—#	BODY BUSHING GASKET.....	1
				25	—▲	TRIGGER NUT.....	1
				26	—▲	TRIGGER SCREW.....	1
				27	—✕	TOP FILTER SEAL.....	1
				28	—✕	BOTTOM FILTER SEAL.....	1

▼ All aircap kits are pre-assembled with Retaining ring and appropriate tip guard. When switching from flat tip to twist tip, or vice versa, be sure to order correct fluid seat (3/3A). For twist tip, item 5B will also be needed.

■ Refer to page 10 for available tip sizes. When purchasing twist tip, discard packaged brace/seal and use Item 5B only.

‡ Pre-assembled with gasket SPA-98.

▲ Available as part of kit 54-5835.

> Available as part of kit 54-5838. Order Filter (12) separately.

● Available as part of kit 54-5827.

\* Available as part of repair kit 54-5825.  
(Includes 1600 PSI Fluid Needle.)

# Available as part of kit 54-5829.

○ Mandatory for operating pressures above 1000 psi.

□ Assembled with filter seals.

✕ Available in 10 pack as part of kit 54-5874-K10  
(note assembly location on next page).

### ACCESSORIES

#### HOSES

71-4990	15' Polyurethane Air Tubing ASM w/fittings, 3/8" O.D., 1/4" I.D.
71-4991	25' Polyurethane Air Tubing ASM w/fittings, 3/8" O.D., 1/4" I.D.
71-4992	15' 1/8" High Pressure Fluid Hose Assembly
71-4993	25' 1/8" High Pressure Fluid Hose Assembly
71-4995	25' 3/16" Low Pressure (1900PSI Max) Fluid Hose Assembly

#### FITTINGS

54-4976-K3	3-Pack 1/4" NPT(f) x 3/8" O.D. Push-In Tube Fitting (optional)
72-2332	Fluid Inlet Swivel (1/4"m x 1/4"f)

#### FLUID FILTER

54-5788-K5	60 Mesh (Screen) Gun Mounted Filter
54-5789-K5	100 Mesh (Screen) Gun Mounted Filter

#### FLUID REGULATOR

845001	Med Pressure Reg. w/Gauge, 6Gpm, 100 to 800 PSI reg range
845010	Med Pressure Reg. w/Gauge, 3Gpm, 400 to 1250 PSI reg range

#### CLEANING KIT

54-4994	Cleaning Kit: Includes one standard stiff nylon pipe cleaning brush, full-size nylon brush, tip cleaner and Binks Gunners Mate lubricant.
---------	---

#### HVLP AIRCAP TEST KITS

54-5836-K	Flat Tip HVLP Aircap Test Kit (Incl Gauge)
54-5837-K	Twist Tip HVLP Aircap Test Kit (Incl Gauge)

#### TEST GAUGES

54-5327	HVLP Test Gauge
---------	-----------------

#### GUN LUBE

6-429	Binks Gunners Mate gun lube, 2 oz. bottle (20/box)
-------	--

# AA1600M AIR-ASSIST AIRLESS SPRAY GUN

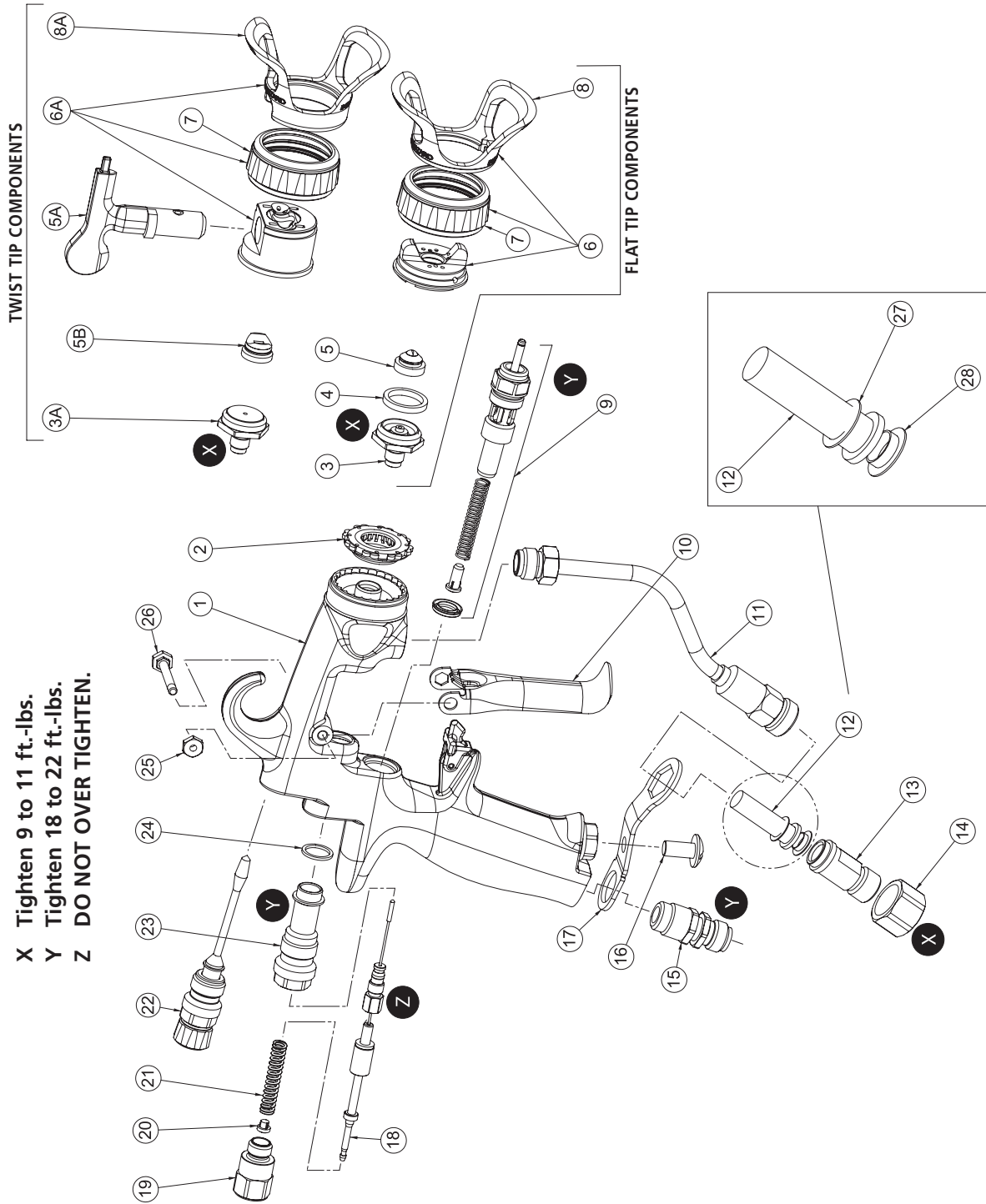

## WARRANTY

This product is covered by Binks' 1 Year Limited Warranty.

**Binks Worldwide Sales and Service Listing: [www.binks.com](http://www.binks.com)**



North American Office  
 ITW Industrial Finishing  
 195 Internationale Blvd.  
 Glendale Heights, IL 60139  
 630-237-5000  
[www.binks.com](http://www.binks.com)

Toll Free Customer Service  
 and Technical Support  
 800-992-4657  
 Toll Free Fax  
 888-246-5732