

XTR™ 5 and XTR™ 7 Airless Spray Gun

Instructions/Parts

See page 7 for model numbers.

Maximum Working Pressure:

XTR 5: 5000 psi (35 MPa, 345 bar)

XTR 7: 7250 psi (50 MPa, 500 bar)

For use with protective coating materials



312145B



IMPORTANT SAFETY INSTRUCTIONS. Refer to your sprayer instruction manual for pressure relief, priming, and spraying instructions. Keep these instructions.

The following warnings are for the setup, use, grounding, maintenance, and repair of this equipment. The exclamation point symbol alerts you to a general warning and the hazard symbols refer to procedure-specific risks. Refer back to these warnings. Additional product-specific warnings may be found throughout the body of this manual where applicable.

! WARNING



SKIN INJECTION HAZARD

High-pressure fluid from gun, hose leaks, or ruptured components will pierce skin. This may look like just a cut, but it is a serious injury that can result in amputation. **Get immediate surgical treatment.**

- Do not point gun at anyone or at any part of the body.
- Do not put your hand over the spray tip.
- Do not stop or deflect leaks with your hand, body, glove, or rag.
- Do not spray without tip guard and trigger guard installed.
- Engage trigger lock when not spraying.
- Follow **Pressure Relief Procedure** in this manual, when you stop spraying and before cleaning, checking, or servicing equipment.



PRESSURIZED EQUIPMENT HAZARD

Fluid from the gun/dispense valve, leaks, or ruptured components can splash in the eyes or on skin and cause serious injury.

- Follow **Pressure Relief Procedure** in this manual, when you stop spraying and before cleaning, checking, or servicing equipment.
- Tighten all fluid connections before operating the equipment.
- Check hoses, tubes, and couplings daily. Replace worn or damaged parts immediately.









FIRE AND EXPLOSION HAZARD

Flammable fumes, such as solvent and paint fumes, in **work area** can ignite or explode. To help prevent fire and explosion:

- Use equipment only in well ventilated area.
- Eliminate all ignition sources; such as pilot lights, cigarettes, portable electric lamps, and plastic drop cloths (potential static arc).
- Keep work area free of debris, including solvent, rags and gasoline.
- Do not plug or unplug power cords or turn power or light switches on or off when flammable fumes are present.
- Ground all equipment in the work area. See **Grounding** instructions.
- Use only grounded hoses.
- Hold gun firmly to side of grounded pail when triggering into pail.
- If there is static sparking or you feel a shock, **stop operation immediately.** Do not use equipment until you identify and correct the problem.
- Keep a working fire extinguisher in the work area.

PROVEN QUALITY. LEADING TECHNOLOGY.

 WARNING	
	<p>EQUIPMENT MISUSE HAZARD</p> <p>Misuse can cause death or serious injury.</p> <ul style="list-style-type: none"> • Do not operate the unit when fatigued or under the influence of drugs or alcohol. • Do not exceed the maximum working pressure or temperature rating of the lowest rated system component. See Technical Data in all equipment manuals. • Use fluids and solvents that are compatible with equipment wetted parts. See Technical Data in all equipment manuals. Read fluid and solvent manufacturer's warnings. For complete information about your material, request MSDS forms from distributor or retailer. • Check equipment daily. Repair or replace worn or damaged parts immediately with genuine manufacturer's replacement parts only. • Do not alter or modify equipment. • Use equipment only for its intended purpose. Call your distributor for information. • Route hoses and cables away from traffic areas, sharp edges, moving parts, and hot surfaces. • Do not kink or over bend hoses or use hoses to pull equipment. • Keep children and animals away from work area. • Comply with all applicable safety regulations.
	<p>PRESSURIZED ALUMINUM PARTS HAZARD</p> <p>Do not use 1,1,1-trichloroethane, methylene chloride, other halogenated hydrocarbon solvents or fluids containing such solvents in pressurized aluminum equipment. Such use can cause serious chemical reaction and equipment rupture, and result in death, serious injury, and property damage.</p>
	<p>TOXIC FLUID OR FUMES HAZARD</p> <p>Toxic fluids or fumes can cause serious injury or death if splashed in the eyes or on skin, inhaled, or swallowed.</p> <ul style="list-style-type: none"> • Read MSDS's to know the specific hazards of the fluids you are using. • Store hazardous fluid in approved containers, and dispose of it according to applicable guidelines. • Always wear impervious gloves when spraying or cleaning equipment.
	<p>BURN HAZARD</p> <p>Equipment surfaces and fluid that's heated can become very hot during operation. To avoid severe burns, do not touch hot fluid or equipment. Wait until equipment/fluid has cooled completely.</p>
	<p>RECOIL HAZARD</p> <p>Gun may recoil when triggered. If you are not standing securely, you could fall and be seriously injured.</p>
	<p>PERSONAL PROTECTIVE EQUIPMENT</p> <p>You must wear appropriate protective equipment when operating, servicing, or when in the operating area of the equipment to help protect you from serious injury, including eye injury, inhalation of toxic fumes, burns, and hearing loss. This equipment includes but is not limited to:</p> <ul style="list-style-type: none"> • Protective eyewear • Clothing and respirator as recommended by the fluid and solvent manufacturer • Gloves • Hearing protection

Pressure Relief Procedure



Follow this Pressure Relief Procedure whenever you are instructed to relieve pressure, stop spraying, check or service equipment, or install or clean spray tip.

1. Engage trigger lock.
2. Shut off pump.
3. Disengage trigger lock.
4. Hold a metal part of the gun firmly to a grounded metal pail. Trigger the gun to relieve pressure.
5. Engage trigger lock.
6. Open fluid drain valve (see **System Requirements**). Leave drain valve open.

If pressure is not fully relieved:

- Spray tip is clogged. For RAC tip, see **Cleaning Tips/Clearing Clogs**, page 4. For flat tip, slowly loosen tip guard retaining nut to relieve pressure. Remove and clear tip.
- Hose is clogged. Slowly loosen hose end coupling to relieve pressure. Clean hose obstruction.

System Requirements

- Install a bleed-type master air valve on a pneumatic pump air supply line to relieve air trapped between this valve and pump after air regulator is shut off. Trapped air can cause the pump to cycle unexpectedly.
- Install a fluid drain valve between the pump and gun to relieve pressure in displacement pump, hose, and gun. Triggering to relieve pressure may not be sufficient. See **Pressure Relief Procedure**.

Grounding



Check your local electrical code and pump/sprayer manual for detailed grounding instructions.

- Spray gun: ground through connection to a grounded fluid hose and pump/sprayer.
- Fluid hose: use only grounded hoses.
- Fluid supply container: follow local code.
- Object being sprayed: follow local code.
- Solvent flushing pails: follow local code. Use only conductive metal pails placed on a grounded surface. Do not place pail on a nonconductive surface, such as paper or cardboard, which interrupts grounding continuity.
- To maintain grounding continuity when flushing or relieving pressure: hold metal part of gun firmly to side of a grounded metal pail, then trigger gun.

Gun Trigger Lock



To prevent injury when the gun is not in use, always engage the gun's trigger lock if unit is being shut down or left unattended. A wallet-sized warning card with important injection treatment information is included with the gun. Additional cards are available at no charge. Provide a card to all operators.

Trigger Locked
(no spray)

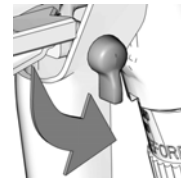

Trigger Unlocked
(spray)



ti5049b

ti5048b

Tip Installation

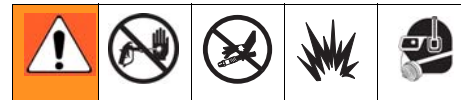

RAC Tip

1. Follow **Pressure Relief Procedure**. Engage trigger lock.

2. Insert housing (A) through back of retaining nut (B) and pull it forward. Install metal seal (20a) in housing (A), flat side first.

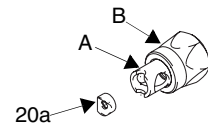

3. Install tip cylinder (20c) so small orifice (X) faces front.

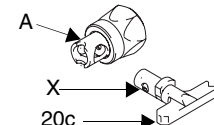

4. Insert tip guard (19) into place. Insert screw (20d) and tighten. Install white gasket (20b) in housing. Install assembled RAC onto spray gun.

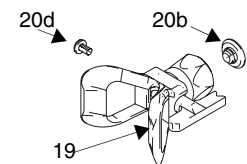

Flat Tip

1. Follow **Pressure Relief Procedure**. Engage trigger lock.
2. Insert tip (32) and gasket (30) into back of guard (31).
3. Install guard over end of gun.

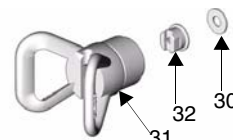

ti10051a

Operation



1. Connect a grounded fluid hose.
2. Without spray tip, flush pump. Use lowest pressure possible.
3. Prime. Refer to sprayer manual.
4. Follow **Pressure Relief Procedure**.
5. Install spray tip and tip guard.
6. RAC tips only: Be sure the arrow-shaped tip faces forward.
7. Hold gun perpendicular and approximately 12 inches (304 mm) from surface. Wear gloves if fluid temperature exceeds 110°F (43°C).
8. Move gun first, then pull gun trigger to spray onto test paper.
 - a. Adjust fluid pressure until spray is completely atomized.
 - b. If adjusting pressure does not give a good spray pattern, follow **Pressure Relief Procedure**, then try another tip size.
9. Trigger gun full-open or full-close.

Adjusting Spray Pattern

The spray tip orifice and spray angle determine pattern coverage and size. When you need more coverage, use a larger spray tip rather than increasing fluid pressure.

1. Follow **Pressure Relief Procedure**. Engage trigger lock.
2. Loosen tip guard retaining nut.
3. Align guard horizontally to spray a horizontal pattern. Align guard vertically to spray a vertical pattern.
4. Tighten nut.

Cleaning Tips/Clearing Clogs



Clean tip and tip guard at end of each work day.

1. Follow **Pressure Relief Procedure**. Engage trigger lock.
2. Clean spray tip as follows:
 - a. RAC tips: Rotate tip 180°. Disengage trigger lock. Trigger gun into pail or onto ground to remove clog. Engage trigger lock. Rotate tip 180° back to spray position.
 - b. Flat tips: Remove tip and clean with a solvent-soaked brush.
3. RAC tips: If tip is still clogged:
 - a. Shut off sprayer and disconnect power source.
 - b. Open fluid drain valve (see **System Requirements** on page 3) to relieve pressure.
 - c. Remove and clean spray tip.

Maintenance



Flushing

Flush pump and gun before fluid can dry in it. If available, use flushing procedure provided in your pump or sprayer manual instead of this procedure.

1. Follow **Pressure Relief Procedure**. Engage trigger lock.
2. Remove spray tip and guard from gun. Clean with solvent.
3. Put the pump intake in a grounded pail of compatible solvent.
4. Start pump at its lowest pressure.
5. Disengage trigger lock, then trigger gun into the paint pail. When solvent appears, release trigger.
6. Trigger gun into solvent pail. Circulate fluid until system is thoroughly flushed.
7. Follow **Pressure Relief Procedure**. Engage trigger lock.

Cleaning/Replacing Filter

1. Follow **Pressure Relief Procedure**. Engage trigger lock.
2. Disconnect trigger guard from gun body by pushing up on guard hook and pulling it out of notch.
3. The trigger guard beneath the gun handle can then be used as a wrench to loosen the nut.
4. When alignment notches are no longer engaged, use your hand to twist handle and remove it from gun head.
5. Remove filter.
6. Clean filter using a soft brush.
7. Replace filter.
8. Apply light coating of grease to threads and then attach.
9. Use trigger guard to tighten the nut.
10. Reattach the trigger guard to the gun.

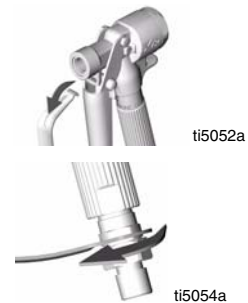

Cleanup

Flush gun after each work shift and store in a dry location. Do not leave the gun or any parts in water or cleaning solvents.

Repair



Disassembly

1. Follow **Pressure Relief Procedure**. Engage trigger lock.
2. Disconnect fluid hose. Remove RAC tip guard and tip (19 and 20a-20d) or flat tip guard and tip (30, 31 and 32).
3. Using a wrench, remove the cap (4) with spring (5) (releases spring tension on needle).
4. Remove the valve seat (10) and gasket (9).
5. Holding the needle with tool (36) remove the needle retainer (6).
6. Pull the needle (8) out.
7. Using a socket wrench, remove the seal retainer (2) from the back of the gun. Use a pick to remove the gasket (3).
8. Clean and replace parts as needed.



If you need to remove the trigger

 To avoid losing parts, be ready for two actuator pins (7) to fall out of the gun body when the trigger (16) is removed.

XTR 7 Guns

1. Using a wrench, remove screw (11b) from the pivot pin (11a).
2. Slide the pivot pin (11a) out of the gun body, and remove the trigger (16).
3. Before installing trigger, grease the actuator pins (7) and the pivot pin (11a).

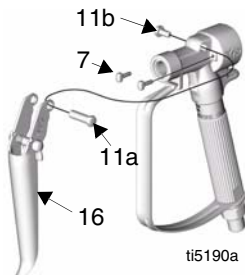

XTR 5 Guns

1. Using a socket wrench, remove screw (12) from each side of the gun body and remove trigger.
2. Before installing trigger, grease the actuator pins (7).

Assembly

1. Press a new gasket (3*) into the gun body. Lightly grease the seal retainer (2*) and install. Torque to 48-72 in-lb (5-8 N•m).
2. Lightly grease and replace the needle (8*). Press the needle through the seal retainer.

Caution
Use only tool (36) and fingers to tighten needle. Do not overtighten or breakage may occur.

3. Apply light-strength Loctite™ to needle threads. Holding the needle with tool (36*), install needle retainer (6). Tighten until it bottoms out. Do not overtighten.
4. Lightly grease valve seat (10*) threads. Squeeze the trigger to retract the needle and install gasket (9*) and valve seat (10*). Torque valve seat to 26-32 ft-lb (34-43 N•m).
5. Grease and install the spring (5) and cap (4). Tighten the cap to 10-13 ft-lb (8-10 N•m).

Test Gun Before Using

1. Engage trigger lock. Connect fluid hose to gun.
2. Start and prime the pump.
3. Disengage the trigger lock and trigger the gun into a metal waste container.
4. Release the trigger. The gun should immediately stop spraying and there should be no leaks. If there is a problem, follow **Pressure Relief Procedure**. Check through **Assembly** procedure and correct problem.
5. Install tip and tip guard before regular use.

Technical Data

Maximum working pressure:

XTR 5 5000 psi (35 MPa, 345 bar)

XTR 7 7250 psi (50 MPa, 500 bar)

Fluid orifice 0.090 in. (2.3 mm)

Fluid inlet 1/4 npsm (m)

Max. fluid temperature 160°F (71°C)

Sound pressure 84.3 dB(A)*

Sound power 95.7 dB(A)*

Wetted parts aluminum, stainless steel, acetal, polyethylene, nylon, polypropylene, carbide, polyurethane, solvent-resistant o-rings.

*Results are maximum readings taken at 6000 psi (41 MPa, 414 bar), with HD519 tip, using water. Sound power level was tested to ISO 9614-2.

Parts

Ref	Part	Description	Qty
1	15J771	BODY, gun, aluminum, (XTR 5 only)	1
	15E178	BODY, gun, sst (XTR 7 only)	1
2*	245881	SEAL, retainer assembly	1
3*	n/a	GASKET (kit 248837 only, not sold separately)	1
4	15K000	CAP, end (XTR 5 only)	1
	15A864	CAP, end (XTR 7 only)	1
5	117350	SPRING,	1
6	15E088	RETAINER, needle	1
7	15E085	PIN, actuator	2
8*	248591	NEEDLE	1
9*	156766	GASKET	1
10*	245858	SEAT, valve	1
11a†	192272	PIN, pivot (XTR 7 only)	1
11b†	203953	SCREW, cap, hex-hd; 10-24 x 3/8 in. (10 mm) [XTR7 only]	1
12†	117602	SCREW, shoulder, pan hd; 8-32 x 5/16 in. (8 mm) [XTR 5 only]	2
13	248952	HANDLE, includes trigger guard, swivel, tube, and o-ring; see Tables 1 and 2	1
14a	276997	HANDLE SLEEVE, insulated, (see Tables 1 and 2)	1
14b	15E083	HANDLE SLEEVE, 1 in. (25 mm), (see Tables 1 and 2)	1
15a	255275	HANDLE, includes trigger guard, swivel, and tube, 1 in. (25 mm) OD, (XTR 5 only, see Table 2)	1
15b	255276	HANDLE, includes trigger guard, swivel, and tube, 7/8 in. (23 mm) OD, (XTR 5 only, see Table 2)	1
16a†	287449	TRIGGER KIT, also includes 11a, 11b, and 12, see Tables 1 and 2,	1
16b†	287450	TRIGGER KIT, also includes 11a, 11b, and 12, see Tables 1 and 2	1
16c†	287451	TRIGGER KIT, also includes 11a, 11b, and 12, see Tables 1 and 2	1
21*	179733	SEAL, sleeve	1
24	n/a	O-RING (kit 248952 only, not sold separately)	1
26	287032	FILTER, 60 mesh, included with gun	1
	287034	FILTER, 60 and 100 mesh combo	1
29▲	222385	TAG, warning (not shown)	1
36*	194744	TOOL, repair, packing	1

▲ Replacement Danger and Warning labels, tags, and cards are available at no cost.

* Parts included in Repair Kit 248837, purchased separately.

† Parts included in Trigger Kits 287449 (16a), 287450 (16b), and 287451 (16c), purchased separately.

Tip and Guard

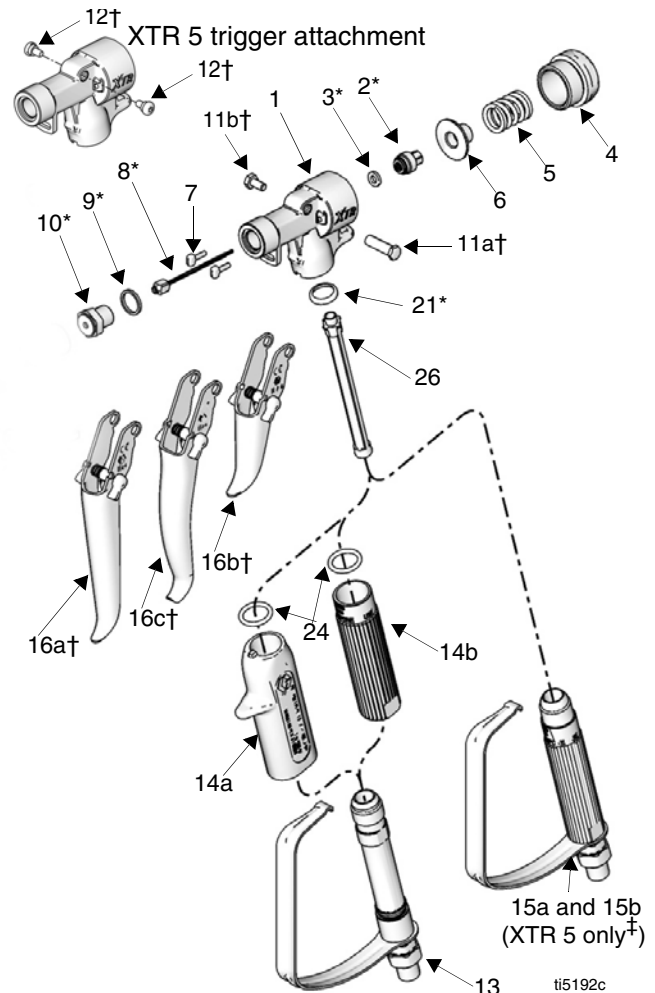

‡ **NOTE:** Handles 15a and 15b are not pressure rated for use with the XTR 7. For an XTR 7, order handle 13 and sleeve 14a or 14b depending on your model (see Table 1).

Ref	Part	Description	Qty
19	245994	GUARD, RAC tip (see Tables 1 and 2)	1
20	GHDxxx	SWITCH, RAC tip, 519 size included (includes 20a - 20d, see Tables 1 and 2)	1
20a		SEAL, fluid	1
20b		GASKET	1
20c		TIP, spray hd RAC	1
20d		SCREW, machine, pan hd, 10-32 x 5/16 in. (8 mm)	1
30	166969	GASKET, (XTR501 and XTR701 only)	1
31	220251	GUARD, flat tip (XTR501 and XTR701 only)	1
32	163519	TIP, flat (XTR501 and XTR701 only)	1

Table 1: XTR 7 Models

XTR 7 Gun Part No.	Reference Numbers							
	13	14a	14b	16a	16b	16c	19	20
XTR700	✓		✓	✓			✓	
XTR701	✓		✓	✓				
XTR702	✓	✓				✓	✓	✓
XTR703	✓	✓			✓		✓	✓
XTR704	✓		✓	✓			✓	✓
XTR705	✓		✓		✓		✓	✓

Table 2: XTR 5 Models

XTR 5 Gun Part No.	Reference Numbers									
	13	14a	14b	15a	15b	16a	16b	16c	19	20
XTR500				✓		✓			✓	
XTR501				✓		✓				
XTR502	✓	✓						✓	✓	✓
XTR503	✓	✓					✓		✓	✓
XTR504				✓		✓			✓	✓
XTR505				✓			✓		✓	✓
XTR506					✓	✓			✓	✓
XTR507					✓		✓		✓	✓

Related Manuals

This manual is available in the following languages. Also see www.graco.com for the latest translations.

Language	Manual
Chinese	312293
Dutch	312138
English	312145
French	312294
German	312295
Italian	312549
Japanese	312296
Korean	312297
Portuguese	312136
Russian	312137
Spanish	312298
Swedish	312139

Graco Standard Warranty

Graco warrants all equipment referenced in this document which is manufactured by Graco and bearing its name to be free from defects in material and workmanship on the date of sale to the original purchaser for use. With the exception of any special, extended, or limited warranty published by Graco, Graco will, for a period of twelve months from the date of sale, repair or replace any part of the equipment determined by Graco to be defective. This warranty applies only when the equipment is installed, operated and maintained in accordance with Graco's written recommendations.

This warranty does not cover, and Graco shall not be liable for general wear and tear, or any malfunction, damage or wear caused by faulty installation, misapplication, abrasion, corrosion, inadequate or improper maintenance, negligence, accident, tampering, or substitution of non-Graco component parts. Nor shall Graco be liable for malfunction, damage or wear caused by the incompatibility of Graco equipment with structures, accessories, equipment or materials not supplied by Graco, or the improper design, manufacture, installation, operation or maintenance of structures, accessories, equipment or materials not supplied by Graco.

This warranty is conditioned upon the prepaid return of the equipment claimed to be defective to an authorized Graco distributor for verification of the claimed defect. If the claimed defect is verified, Graco will repair or replace free of charge any defective parts. The equipment will be returned to the original purchaser transportation prepaid. If inspection of the equipment does not disclose any defect in material or workmanship, repairs will be made at a reasonable charge, which charges may include the costs of parts, labor, and transportation.

THIS WARRANTY IS EXCLUSIVE, AND IS IN LIEU OF ANY OTHER WARRANTIES, EXPRESS OR IMPLIED, INCLUDING BUT NOT LIMITED TO WARRANTY OF MERCHANTABILITY OR WARRANTY OF FITNESS FOR A PARTICULAR PURPOSE.

Graco's sole obligation and buyer's sole remedy for any breach of warranty shall be as set forth above. The buyer agrees that no other remedy (including, but not limited to, incidental or consequential damages for lost profits, lost sales, injury to person or property, or any other incidental or consequential loss) shall be available. Any action for breach of warranty must be brought within two (2) years of the date of sale.

GRACO MAKES NO WARRANTY, AND DISCLAIMS ALL IMPLIED WARRANTIES OF MERCHANTABILITY AND FITNESS FOR A PARTICULAR PURPOSE, IN CONNECTION WITH ACCESSORIES, EQUIPMENT, MATERIALS OR COMPONENTS SOLD BUT NOT MANUFACTURED BY GRACO. These items sold, but not manufactured by Graco (such as electric motors, switches, hose, etc.), are subject to the warranty, if any, of their manufacturer. Graco will provide purchaser with reasonable assistance in making any claim for breach of these warranties.

In no event will Graco be liable for indirect, incidental, special or consequential damages resulting from Graco supplying equipment hereunder, or the furnishing, performance, or use of any products or other goods sold hereto, whether due to a breach of contract, breach of warranty, the negligence of Graco, or otherwise.

FOR GRACO CANADA CUSTOMERS

The Parties acknowledge that they have required that the present document, as well as all documents, notices and legal proceedings entered into, given or instituted pursuant hereto or relating directly or indirectly hereto, be drawn up in English. Les parties reconnaissent avoir convenu que la rédaction du présente document sera en Anglais, ainsi que tous documents, avis et procédures judiciaires exécutés, donnés ou intentés, à la suite de ou en rapport, directement ou indirectement, avec les procédures concernées.

Graco Information

TO PLACE AN ORDER, contact your Graco distributor or call to identify the nearest distributor.

Phone: 612-623-6921 **or Toll Free:** 1-800-328-0211 **Fax:** 612-378-3505

All written and visual data contained in this document reflects the latest product information available at the time of publication. Graco reserves the right to make changes at any time without notice.

This manual contains English. MM 312145

Graco Headquarters: Minneapolis

International Offices: Belgium, China, Japan, Korea

GRACO INC. P.O. BOX 1441 MINNEAPOLIS, MN 55440-1441
312145B, 9/2007